

8415 - GR TRITON PLUS

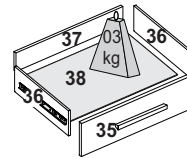
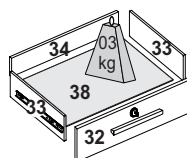
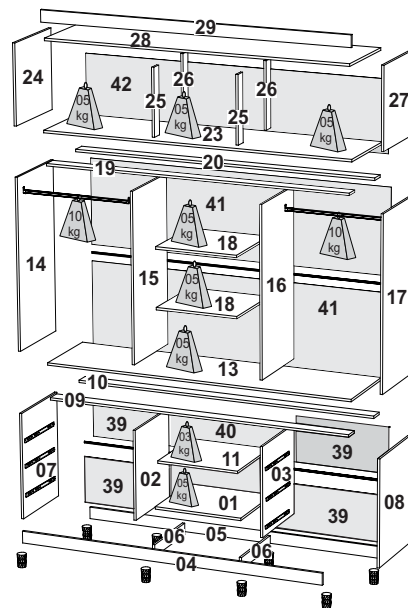
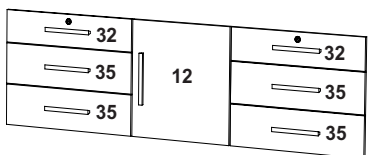
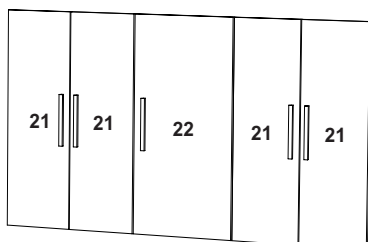
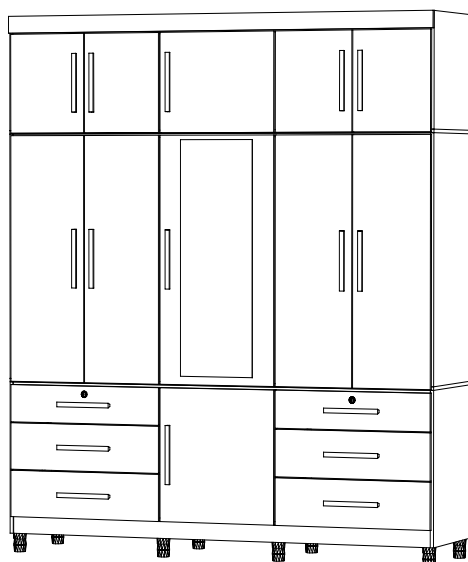

INSTRUÇÃO MONTAGEM PRODUTO ASSEMBLY INSTRUCTION / INSTRUCCIONES DE MONTAJE

Separe as peças e acessórios de maneira organizada

Separate parts and accessories in way organized

Separe las piezas y accesorios de manera organizada

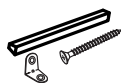

Forrar o chão com o papelão das embalagens

Cover the floor with the cardboard

Cubra el suelo con la embalaje de cartón

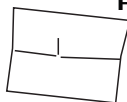

É necessário 1 pessoa para montar o produto

It is necessary one person to assembly

Es necesario una persona para ensamblar

Ferramentas necessárias
(não fornecidas)
Not include tools/
No herramientas



CUIDADO PARA CONSERVAÇÃO E LIMPEZA DO MÓVEL CARE TO CONSERVATION AND CLEAN CUIDADO PARA LA CONSERVACIÓN Y LA LIMPIEZA

O peso máximo de carga informado refere-se a objetos distribuído de maneira uniforme sobre toda área de contato da peça.



Set maximum weight load refers to objects distributed uniformly over the entire contact area of the workpiece.

Conjunto de carga máxima de peso se refiere a objetos distribuidos uniformemente sobre toda el área de contacto de la pieza de trabajo.



Não molhar o móvel e não expor em lugar úmido

Do not wet the mobile and do not expose in a wet place

No moje el producto y no exponer en un lugar húmedo



Não expor o móvel próximo de fontes de calor

Do not expose the mobile near heat sources

no exponga cercano de fuentes de calor



Não usar produtos abrasivos.

Do not use abrasive products.











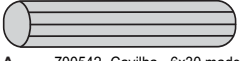

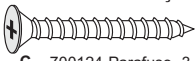

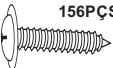

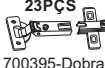



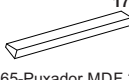
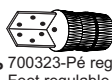

No utilice productos abrasivos.

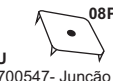

Limpe com flanela limpa e seca.

Clean with dry cloth

Limpeza con un paño limpio y seco

 A 700542-Cavilha - 6x30 madeira Dowel / Clavija	 B 700137-Parafuso 4,5x45 Screw / tornillo	 C 700124-Parafuso -3,5x25 Screw / Tornillo	 D 700120-Parafuso -3,0x12 Screw / Tornillo	 E 700121-Parafuso -3,5x12 Screw / Tornillo		
 F 700129- Parafuso - 4,0x14 Screw / Tornillo	 G 700157-Prego - 10x10 Nail / Clavo	 H 700395-Dobradiça 700390-Calço Hinge / Bisagra	 I 700438- Suporte oblongo Support / Soporte	 J 700446-Porca cilíndrica Cylindrical Nut / Tuerca	 K 700440-Suporte prateleira Shelf Support soporte estantería	 L 700113-Kit corredeira Kit slider / kit corredera
 M 700538-Cantoneira Corner Esquinero	 N SACHE cola 20g glue / goma	 O 700165-Puxador MDF 250mm Handle / Jalador	 P 700323-Pé regulável Feet regulable Pies regulables	 Q 700286-Kit fechadura Kit key / kit llave	 R 700537-Batente fechadura lock / bloqueo	 S 700320-Perfil H 1982mm frame / perfil
 T 700319-Perfil H 710mm Frame / Perfil	 U 700547- Junção traseira Rear / Junción	 V 700322-Bastão alumínio 700 mm Aluminum Stick / Bate	 W 700419-Tapa furo cover hole / tapa del agujero	 X 700539-Cantoneira coner / esquina	 Y 700315-Espelho Mirror / Espejo	 albatroz móveis 700566-Logomarca / Logo

Nº	REFERENCIA	DESCRIÇÃO DA PEÇA	DESCRIPTION OF PIECES	DESCRIPCIÓN DE PIEZAS	MAT. PRIMA	MEDIDAS	QTD
1	306281	Base mod.inferior	Base base module	Módulo base base	MDP	572x495x15	1
2	306282	Divisória esquerda mod.inferior	Left partition lower module	Módulo inferior partición izquierda	MDP	550x495x15	1
3	306283	Divisória direita mod.inferior	Right partition lower module	Módulo inferior partición derecha	MDP	550x495x15	1
4	306284	Rodapé frontal mod.inferior	Front footer lower module	Módulo inferior del pie de página frontal	MDP	1982x72x15	1
5	306285	Rodapé traseiro mod.inferior	Lower module rear skirting	Zócalo trasero del módulo inferior	MDP	1982x72x15	1
6	306286	Trava rodapé mod.inferior	Lower module footer lock	Bloqueo de pie de página del módulo inferior	MDP	464x72x15	2
7	306287	Lateral esquerda mod.inferior	Left side lower module	Módulo inferior del lado izquierdo	MDP	652x495x15	1
8	306288	Lateral direita mod.inferior	Right side lower module	Módulo inferior del lado derecho	MDP	652x495x15	1
9	306289	Trava frontal mod.inferior	Front lock lower module	Módulo inferior de bloqueo frontal	MDP	1982x88x15	1
10	306290	Trava traseira mod.inferior	Rear module lower lock	Bloqueo inferior del módulo trasero	MDP	1982x88x15	1
11	306291	Prateleira móvel mod.inferior	Mobile shelf lower module	Módulo inferior de balda móvil	MDP	532x495x15	1
12	306292	Porta mod.inferior	Lower module door	Puerta del módulo inferior	MDP	568x540x15	1
13	306293	Base mod.central	Central module base	Base del módulo central	MDP	2012x495x15	1
14	306294	Lateral esquerda mod.central	Left side central module	Módulo central del lado izquierdo	MDP	1050x495x15	1
15	306295	Divisória esquerda mod.central	Left central module partition	Partición del módulo central izquierdo	MDP	1035x495x15	1
16	306296	Divisória direita mod.central	Right central module partition	Partición del módulo central derecho	MDP	1035x495x15	1
17	306297	Lateral direita mod.central	Right side central module	Módulo central del lado derecho	MDP	1050x495x15	1
18	306298	Prateleira mod.central	Central module shelf	Estante del módulo central	MDP	532x495x15	2
19	306299	Trava frontal mod.central	Central module front lock	Bloqueo frontal del módulo central	MDP	1982x88x15	1
20	306300	Trava traseira mod.central	Central module rear lock	Bloqueo trasero del módulo central	MDP	1982x88x15	1
21	306301	Porta mod.central	Central module door	Puerta del módulo central	MDP	1060x358x15	4
22	306302	Porta do espelho mod.central	Door with mirror central module	Puerta con espejo de módulo central	MDP	1060x540x15	1
23	306303	Base mod.superior	Top module base	Base del módulo superior	MDP	2012x495x15	1
24	306304	Lateral esquerda mod.superior	Left side top module	Módulo superior del lado izquierdo	MDP	490x495x15	1
25	306305	Batente frontal mod.superior	Top module front stop	Tope delantero del módulo superior	MDP	408x72x15	2
26	306306	Batente traseiro mod.superior	Top module rear stop	Tope trasero del módulo superior	MDP	408x72x15	2
27	306307	Lateral direita mod.superior	Right side top module	Módulo superior del lado derecho	MDP	490x495x15	1
28	306308	Chapéu mod.superior	Top module hat	Sombrero de módulo superior	MDP	1982x495x15	1
29	306309	Vista frontal mod.superior	Top module front view	Vista frontal del módulo superior	MDP	2012x72x15	1
30	306310	Porta mod.superior	Top module door	Puerta del módulo superior	MDP	427x358x15	4
31	306311	Porta maior mod.superior	Larger upper module door	Puerta del módulo superior más grande	MDP	427x540x15	1
32	306312	Frente gv./chave menor mod.inf.	Front drawer with lower key lower module	Cajón frontal con módulo inferior de llave inferior	MDP	718x160x15	2
33	700318	Lateral gaveta menor mod.inf.	Side lower drawer lower module	Módulo inferior del cajón inferior lateral	MDP	380x100x12	4
34	306314	Contra fundo menor mod.inf.	Against bottom lower module	Contra el módulo inferior inferior	MDP	662x88x12	2
35	306315	Frente gaveta maior mod.inf.	Larger drawer front lower module	Módulo inferior delantero de cajón más grande	MDP	718x200x15	4
36	700317	Lateral gaveta maior mod.inf.	Side drawer larger bottom module	Módulo inferior más grande del cajón lateral	MDP	380x141x12	8
37	306317	Contra fundo maior mod.inf.	Against a larger bottom bottom module	Contra un módulo inferior inferior más grande	MDP	662x130x12	4
38	306318	Fundo da gaveta mod.inferior	Bottom drawer bottom module	Módulo inferior del cajón inferior	HDF	686x385x3	6
39	306319	Fundo dir./esq. Mod.inferior	Bottom right bottom module	Módulo inferior derecho inferior	HDF	730x285x3	4
40	306320	Fundo central mod.inferior	Central bottom bottom module	Módulo inferior central inferior	HDF	545x575x3	1
41	306321	Fundo mod.central	Central module background	Fondo del módulo central	HDF	2006x527x3	2
42	306322	Fundo mod. Superior	Top module bottom	Parte inferior del módulo superior	HDF	2006x435x3	1

PASSO 1 Prepare as peças 02,03,07 e 08 utilizando as ferragens (D,L e K).
Prepare as peças 12,21,22,30 e 31 com as ferragens (C,E,H,O e L).

Step 1 Prepare the pieces 02,03,07 and 08 using (D,L and K)
Prepare the pieces 12,21,22,30 and 31 using (C,E,H,O and L)

Paso 1 Prepare las piezas 02,03,07 y 08 usando (D,L y K)
Prepare las piezas 12,21,22,30 y 31 usando (C,E,H,O y L)

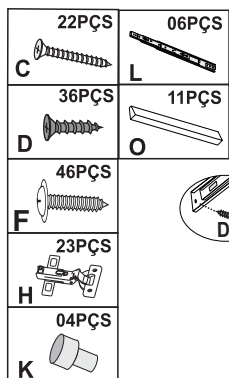

Colocar 3º parafuso no primeiro furo da correção.
Put the 3rd screw in the first hole.
Ponga el tercer tornillo en el hoyo

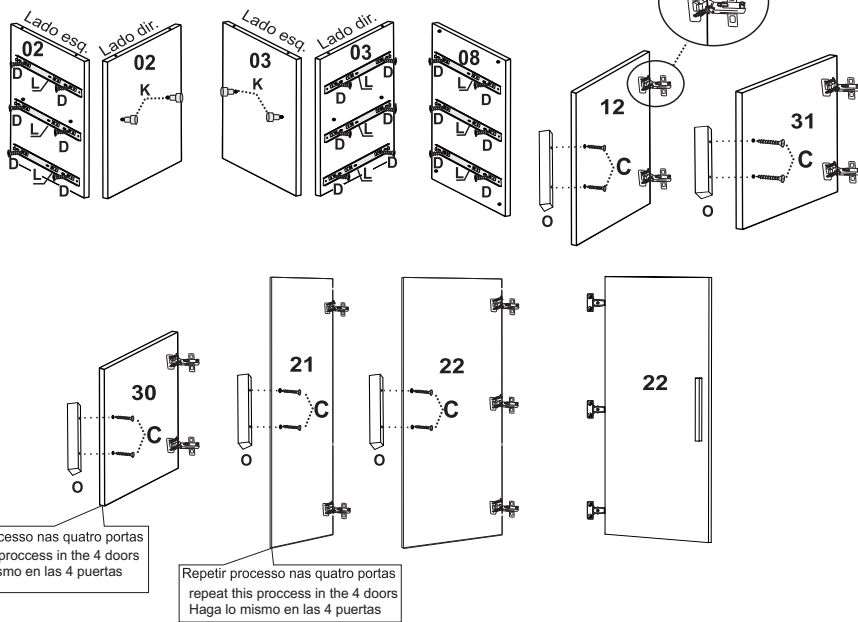
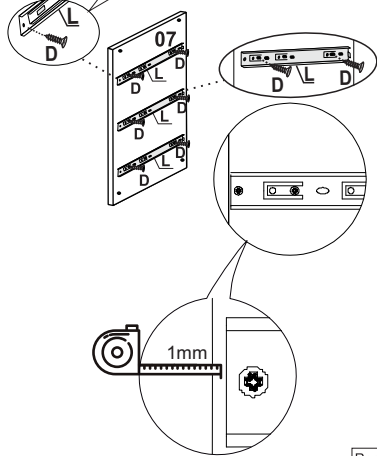

PASSO 2 Fixar as peças 2 e 3 na peça 1 utilizando a ferragem (B).

Step 2 Fix the pieces 02 y 03 in the 01 using tool B

Paso 2 Fije las piezas 02 y 03 na pieza 01 usando la herramienta B

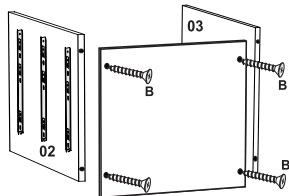
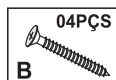

PASSO 3 Fixar as peças 06 nas peças 04 e 05 utilizando a ferragem (B)

Step 3 fix pieces 06 in the 04 and 05 using the tool B / fix pieces 04 and 05 in the 01 using tool B

Paso 3 Fije las piezas 06 na 04 y 05 usando la herramienta B / fije las piezas 04 y 05 usando la herramienta B

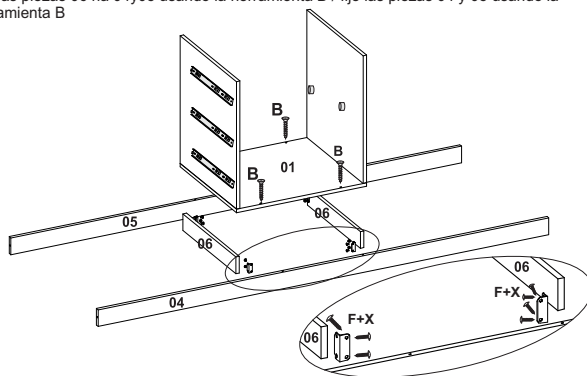
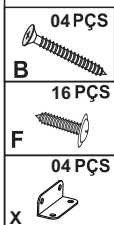

PASSO 4 Fixar as peças 09 e 10 nas peças 02 e 03 utilizando a ferragem (B)

Step 4 Fix piece 09 and 10 in the 02 and 03 pieces using B / Fix 07 and 08 in the 04,05,09 and 10 using B

Paso 4 Fije las piezas 09 y 10 en las 02 y 03 con B / Fije 07 y 08 en las piezas 04,05,09 y 10 usando B

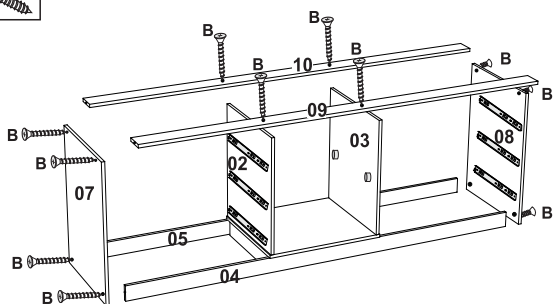
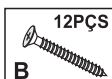

PASSO 5 Fixar o acessório (P) nas peças 04,05,06,07 e 08 utilizando a ferragem (F)

Step 5 Fix the accessory P in the 04,05,06,07 and 08 using the tool F

Paso 5 Fije el accesorio P en las piezas 04,05,06,07 y 08 usando la herramienta F

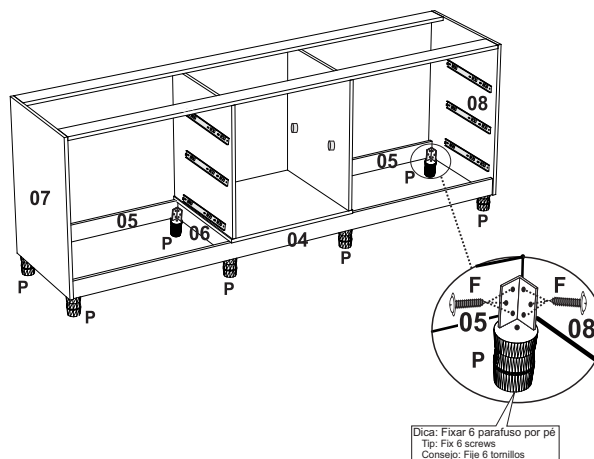
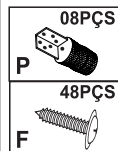



Dica: Fixar 6 parafusos por pé
Tip: Fix 6 screws
Consejo: Fije 6 tornillos

PASSO 6 Fixar o acessório (R) na peça 09 utilizando ferragem (E)
 Fixar a peça 12 na peça 03 utilizando a ferragem (E)

Step 6 Fix the accessory R in the piece 9 using E
 Fix the piece 12 in the 3 using E

Paso 6 Fije R en la pieza 9 usando la herraje E
 Fije la pieza 12 en la 3 usando E

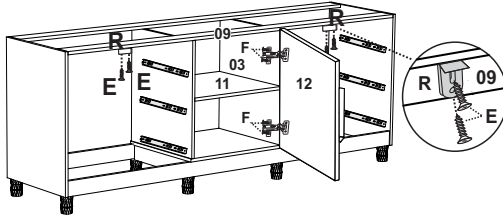

- 04PÇS
E 
- 02PÇS
R 
- 04PÇS
F 



PASSO 7 Preguar as peças 39 e utilizar o acessório (S) entre as duas peças. Preguar a peça 40 e utilizar o acessório (U).

Step 7 Preach the pieces 39 using S between 2 pieces
 Preach the piece 40 using U

Paso 7 Ponga clavos en las piezas 39 usando S entre las piezas
 Ponga clavos en la pieza 40 usando U

- 36PÇS
G 
- 02PÇS
T 
- 08PÇS
U 

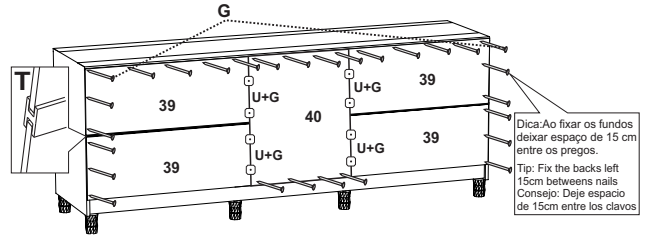

PASSO 8 Fixar as peças 14, 15, 16 e 17 na peça 13 utilizando ferragem (B)

Step 8 Fix the pieces 14, 15, 16, 17 in the 13 using B

Paso 8 Fije las piezas 14, 15, 16, 17 en la 13 usando B

- 08PÇS
B 

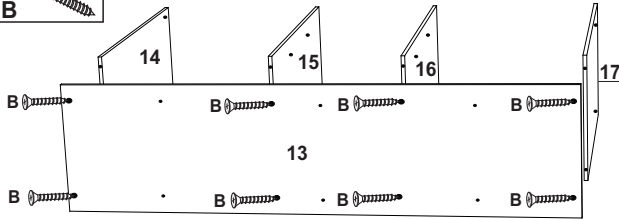

PASSO 9 Fixar as peças 18 nas peças 15 e 16 utilizando ferragem (B)
 Fixar as peças 19 e 20 nas peças 14, 15, 16 e 17 utilizando ferragem (B)

Step 9 Fix 18 in the 15 and 16 using B
 Fix 19 and 20 in the 14, 15, 16, 17 using B

Paso 9 Fije la pieza 18 en 15 y 16 usando B
 Fije 19 y 20 en las piezas 14, 15, 16 y 17 usando B

- 16PÇS
B 

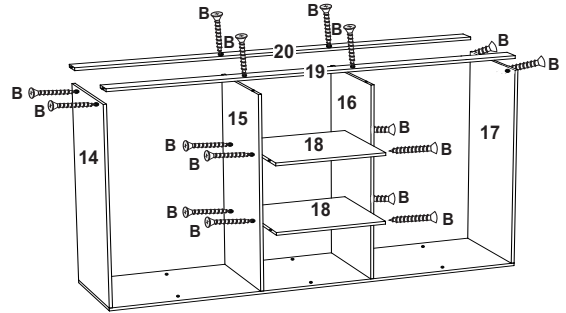

PASSO 10 Fixar as peças 21 nas peças 14, 15, 16 e 17 utilizando ferragem (E). Fixar a peça 22 na peça 16 utilizando a ferragem (E)

Step 10 Fix 21 in the 14, 15, 16, 17 using E
 Fix 22 in the 16 using E

Paso 10 Fije 21 en las piezas 14, 15, 16, 17 usando E
 Fije 22 en la pieza 16 usando E

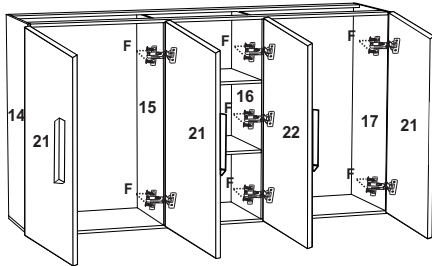

- 22PÇS
F 



PASSO 11 Preguar as peças 41 e utilizar o acessório (S) entre as duas peças.

Step 11 Preach 41 using S between two pieces

Paso 11 Ponga Clavos en las piezas 41 usando S entre ellos

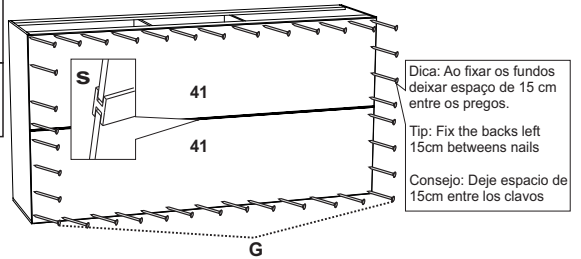

- 38PÇS
G 
- 01PÇ
S 



PASSO 12 Fixar as peças 24 e 27 na peça 23 utilizando ferragem (B)
 Fixar as peças 25 e 26 na peça 23 utilizando as ferragens (A e B)

Step 12 Fix 24 and 27 in the 23 using B
 Fix 25 and 26 in the 23 using A and B

Paso 12 Fije 24 y 27 en la 23 usando B
 Fije 25 y 26 en la 23 usando A y B

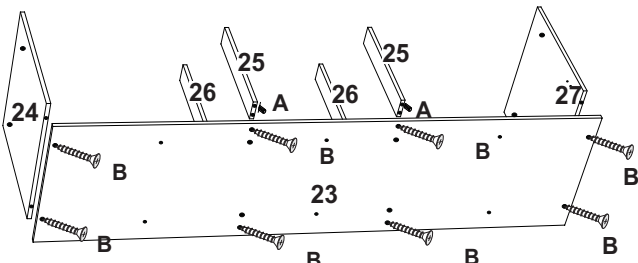

- 04PÇS
A 
- 08PÇS
B 



PASSO 13 Fixar as peças 24 e 27 na peça 28 utilizando ferragem (B e J)
 Fixar as peças 25 e 26 na peça 28 utilizando as ferragens (A e B)

Step 13 Fix 24 and 27 in the 28 using B and J
 Fix 25 and 26 in the 28 using A and B

Paso 13 Fije 24 y 27 en la 28 usando B y J
 Fije 25 y 26 en la 28 usando A y B

- 04PÇS
A 
- 08PÇS
B 
- 04PÇS
J 

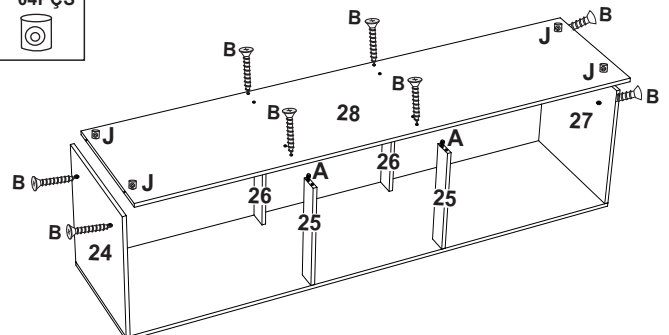

PASSO 14 Fixar a peça 29 na peça 28 utilizando as ferragens (M e D).
Fixar as peças 30 nas peças 24, 25 e 27 utilizando ferragem (E). Fixar a peça 31 na peça 25 utilizando ferragem (E).

Step 14 Fix 29 in the 28 using M and D. Fix 30 in the 24, 25 and 27 using E. Fix 31 in the 25 using E

Paso 14 Fije 29 en la 28 usando M y D. Fije 30 en la 24, 25 y 27 usando E. Fije 31 en la 25 usando E

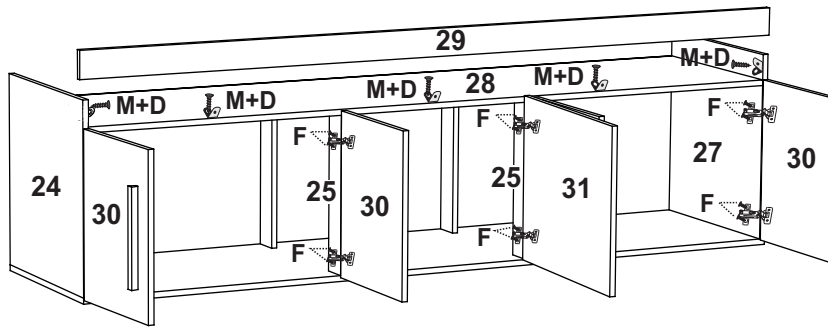
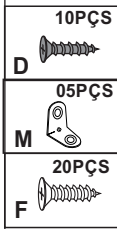

PASSO 15 Pregar a peça 42

Step 15 Preach the piece 42

Paso 15 Ponga clavos en la pieza 42

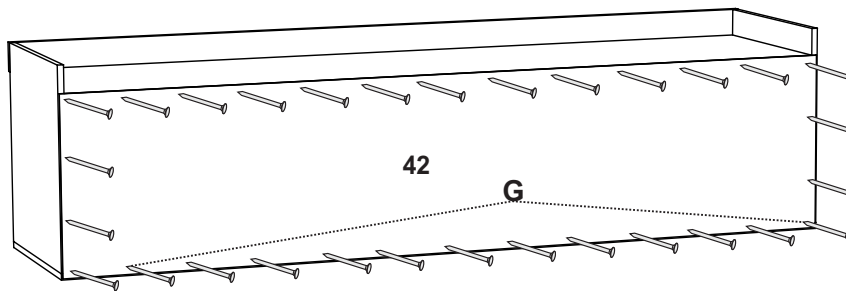

PASSO 1 Preparar as peças 36 utilizando as ferragens (A,D,T e N) e fixar na peça 35. Fixar a peça 37 nas peças 36 utilizando a ferragem(C).Fixar o acessório (O) na peça 35 utilizando a ferragem (C).

Step 1 Prepare the pieces 36 using ADT and N and fix in the 35. Fix 37 in the 36 using C. Fix O in the 35 using C

Paso 1 Prepare la pieza 36 usando ADTN y fije en la 35. Fije la 37 en la 36 usando C. Fije el accesorio O en la 35 usando C

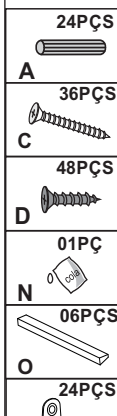

MONTAGEM DA GAVETA
Assembly drawer / Montaje de cajon

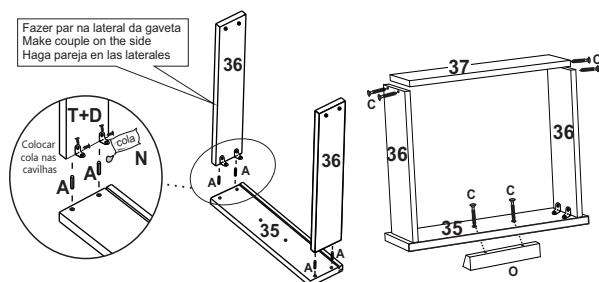

PASSO 2 Fixar a peça 38 nas peças 36 e 37 utilizando a ferragem (G e D). Fixar o acessório (L) na peça 36 utilizando a ferragem (E).

Step 2 Fix 38 in the 36 and 37 using G,D. Fix L in the 38, 36 using E

Paso 2 Fije la 38 en las 36, 37 usando G y D. Fije L en las 38 y 36 usando E

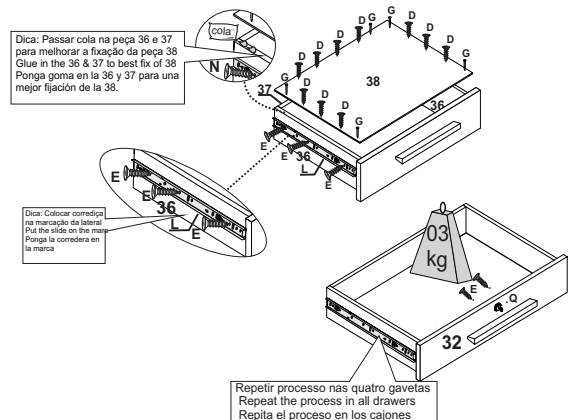
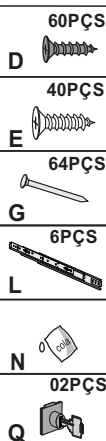

Fixar as três partes utilizando a ferragem (C). Fixar os acessórios (I) nas peças 14, 15, 16 e 17 utilizando ferragem (E), encaixar acessório (V) nos acessórios (I).

Fix the three parts using C. Fix I in the 12, 15, 16, 17 using E. Put the V in the I.

Fije las 3 partes usando C. Fije el I en las piezas 14, 15, 16, 17 usando E, encaje V en la I.

- 12PÇS
C
- 08PÇS
E
- 04PÇS
I
- 02PÇS
V

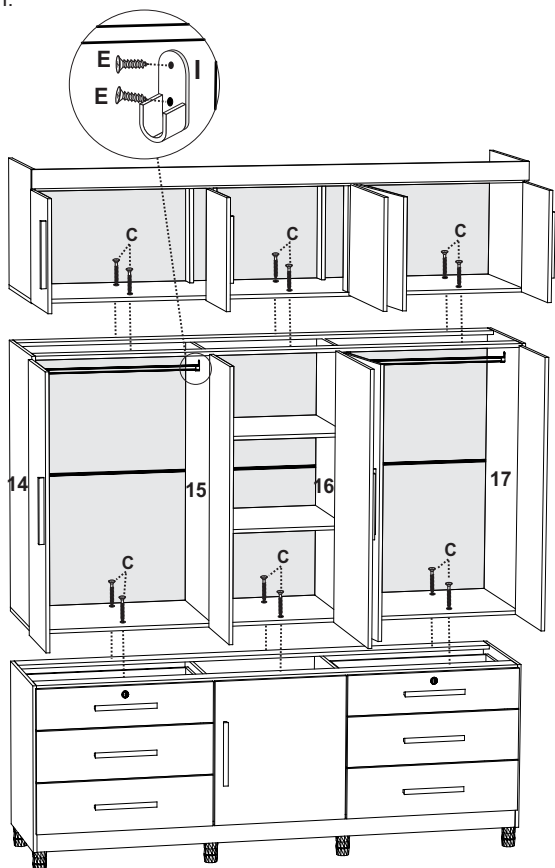

Fixe o espelho Y conforme as dimensões

Fix mirror Y according to dimensions

Fijar espejo Y según dimensiones

Atenção / Watch / Atención

Antes de colar o espelho. Favor, limpar a superfície da peça com um pano seco

Before gluing the mirror. Please clean the surface of the piece with a dry cloth

Antes de pegar el espejo Por favor, limpie la superficie de la pieza con un paño seco

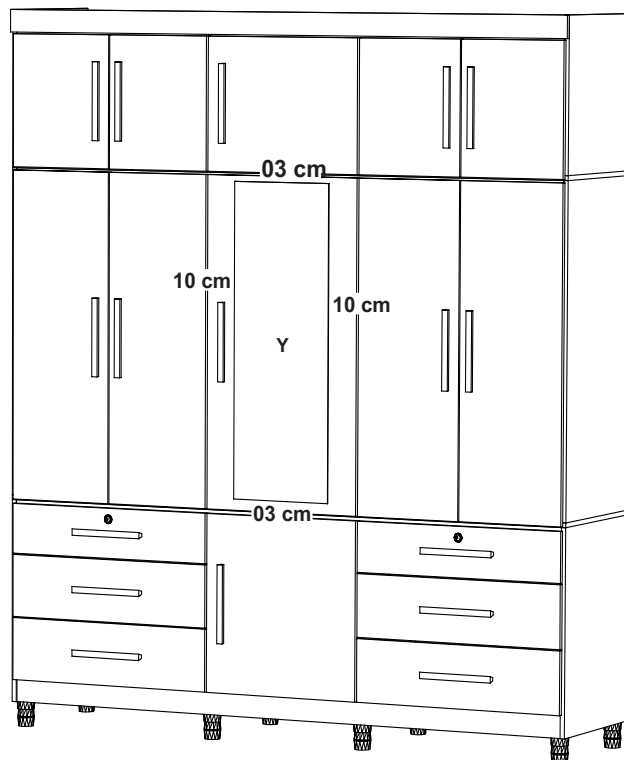

ASPECTO FINAL DO PRODUTO

FINAL ASPECT OF PRODUCT
DISEÑO FINAL DEL PRODUCTO

